

# Lantech

## I(P)GS-0008B

8 10/100/1000T (PoE at/af) Industrial  
Unmanaged Ethernet Switch

## I(P)ES-0008B

8 10/100TX (PoE at/af) Industrial  
Unmanaged Ethernet Switch

---

### User Manual



V1.10  
Nov-2017

## Recommendation for Shielded network cables

STP cables have additional shielding material that is used to reduce external interference. The shield also reduces the emission at any point in the path of the cable. Our recommendation is to deploy an STP network cable in demanding electrical environments. Examples of demanding indoor environments are where the network cable is located in parallel with electrical mains supply cables or where large inductive loads such as motors or contactors are in close vicinity to the camera or its cable. It is also mandatory to use an STP cable where the power device (like IP camera) is used outdoors or where the network cable is routed outdoors.

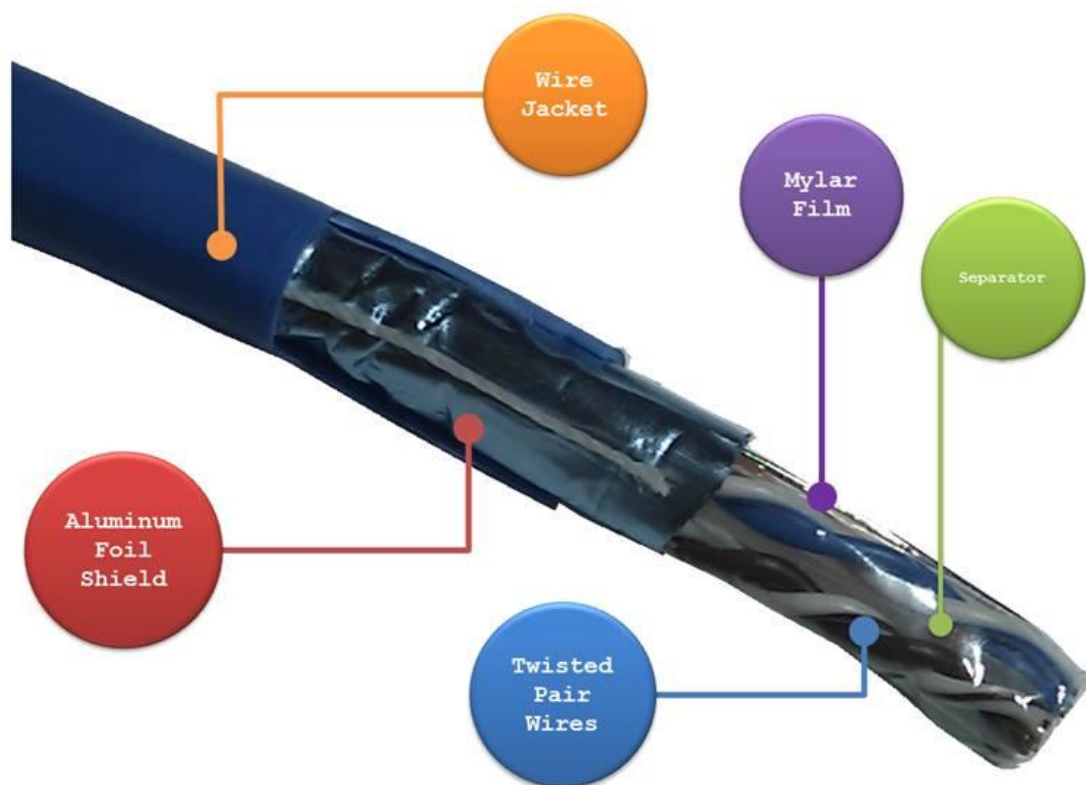

# Content

---

Overview.....	1
Introduction .....	1
Model Lists .....	1
Packing List.....	2
Safety Precaution.....	2
Hardware Description .....	3
Front Panel.....	3
Top View .....	4
Dimensions .....	4
Wiring the Power Inputs .....	6
Wiring the Fault Alarm Contact .....	6
LED Indicators.....	8
RJ-45 Pin Assignments.....	9
Cabling .....	11
Mounting Installation .....	12
DIN-Rail Mounting.....	12
Wall-Mount Plate Mounting .....	14

Hardware Installation.....	15
Installation Steps.....	16
Troubleshooting.....	17

# Overview

---

---

## Introduction

The unmanaged industrial switch is a cost-effective solution and meets the high reliability requirements demanded by industrial applications.

## Model Lists

<b>Model name</b>	<b>10/100/1000T ports</b>	<b>10/100TX ports</b>	<b>PoE ports</b>
IPGS-0008B	8	-	8
IPES-0008B	-	8	8
IGS-0008B	8	-	NA
IES-0008B	-	8	NA

For latest product specifications, please refer to [Lantech official site](#).

## **Packing List**

- 1 x 8-port Industrial Ethernet Switch
- 1 x Terminal Block

## **Safety Precaution**

*Attention* If DC voltage is supplied by an external circuit, please use a protection device on the power supply input.

# Hardware Description

---

In this paragraph, we will introduce the Industrial switch's dimensions, port, cabling information, and wiring installation.

## Front Panel

The Front Panel of the **IGS-0008B/IPGS-0008B/IES-0008B/IPES-0008B** is shown as below.

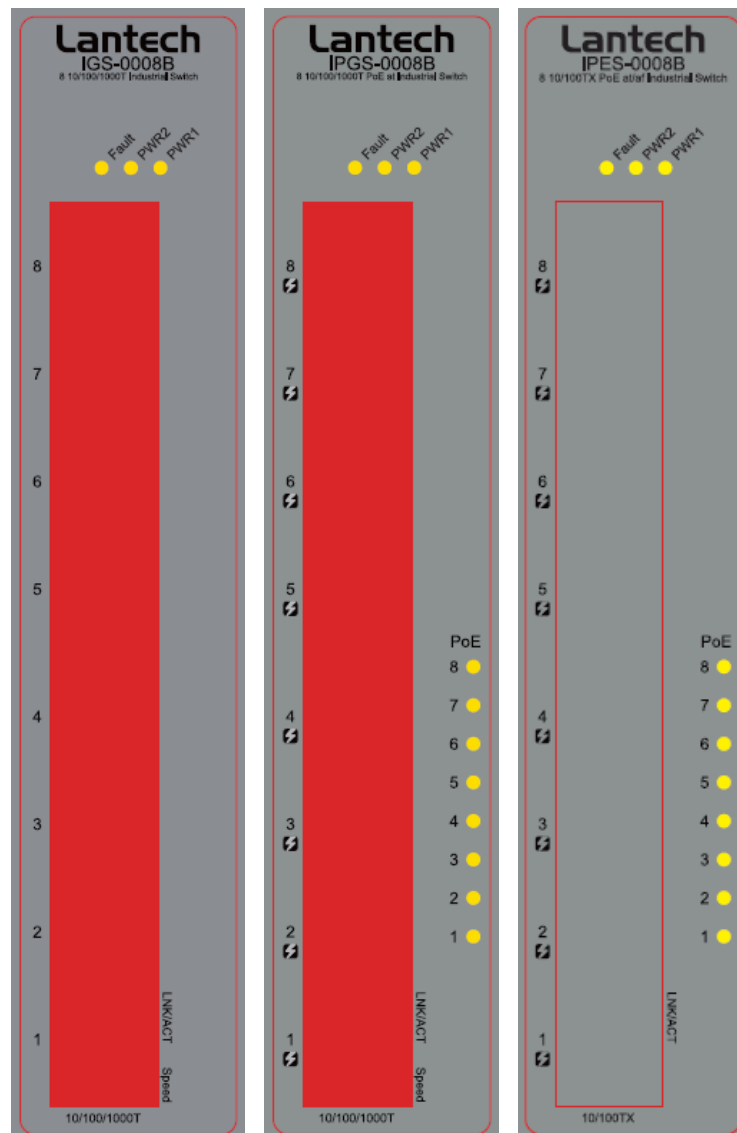

Front Panel of the Industrial Switch

## Top View

The top panel of the Industrial Switch is equipped one terminal block connector of two DC power inputs.

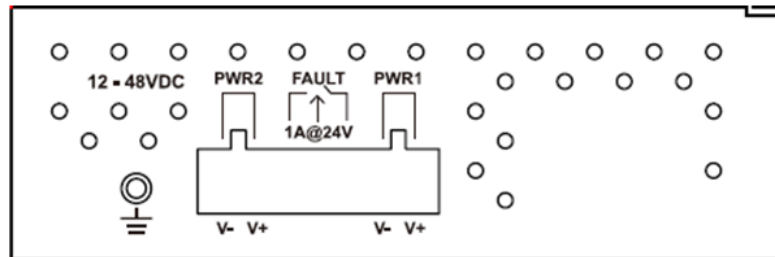

Top panel of the Industrial Switch Converter

## Dimensions

. The dimensions of IGS-0008B/IES-0008B are 35 x 152 x 105 mm (W x H x D). The figure below gives the dimensions and views of each side of the 8-port 10/100/1000Base-T Industrial Switch.

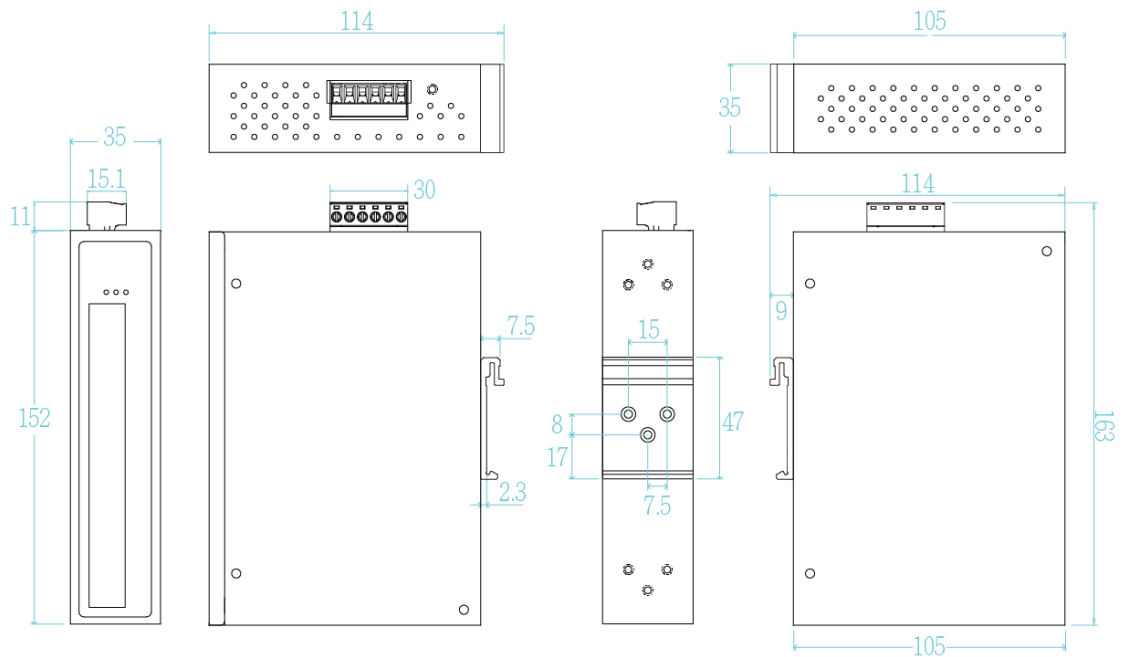



The dimensions of IPGS-0008B/IPES-0008B are 43 x 152 x 105 mm (W x H x D). The figure below gives the dimensions and views of each side of the 8-port 10/100/1000Base-T Industrial Switch.

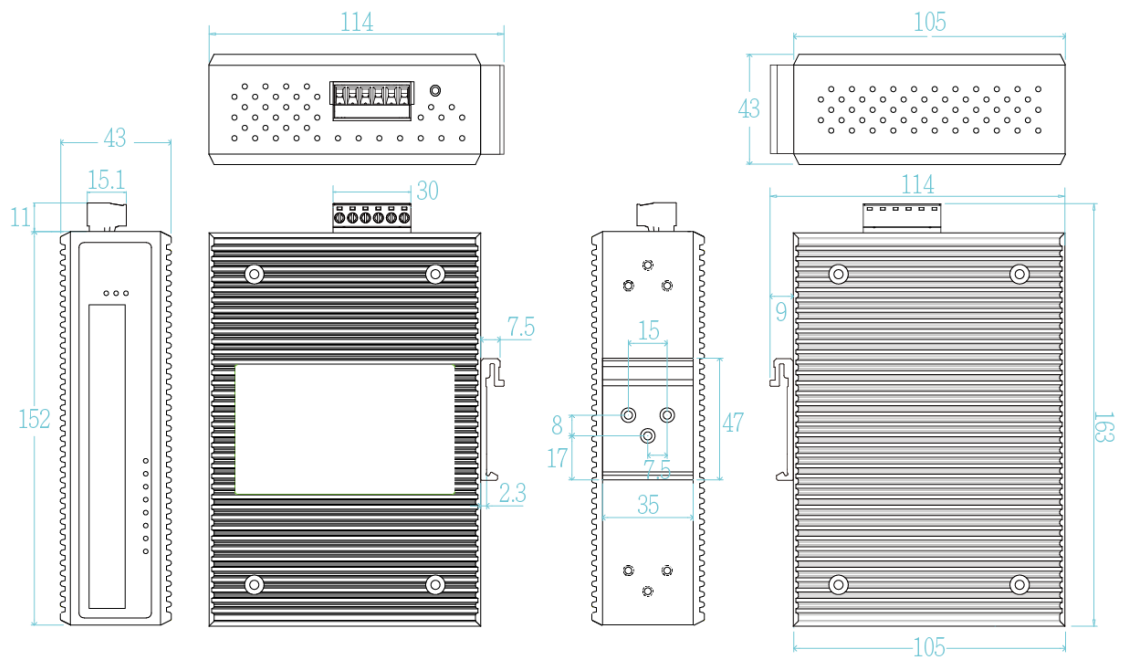

## Wiring the Power Inputs

Please follow the steps below to insert the power wire.

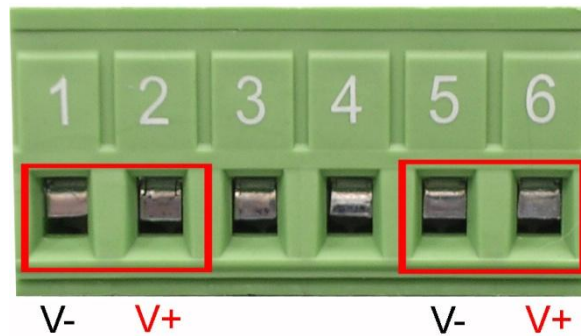

1. Insert the positive and negative wires into the V+ and V- contacts on the terminal block connector.



2. To tighten the wire-clamp screws for preventing the DC wires to loose.

## Wiring the Fault Alarm Contact

The fault alarm contact is in the middle of terminal block connector as the picture shows below. Inserting the wires, it will detect the fault status which the power is failure or port link failure (for managed model) and form an open circuit.

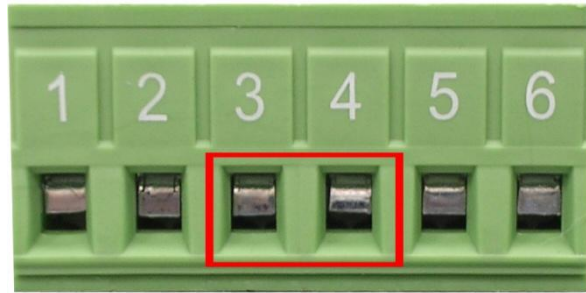

Insert the wires into the fault alarm contact (No. 3 & 4)

---

**Note**     *The wire gauge for the terminal block should be in the range between 12~ 24 AWG.*

---

## LED Indicators

The LED indicators located on the front panel display the power status and network status of the Industrial switch; each has their own specific meaning as the table shown below.

LED	Color	Description	
P1	Green	On	Power input 1 is active
		Off	Power input 1 is inactive
P2	Green	On	Power input 2 is active
		Off	Power input 2 is inactive
Fault	Red	On	Power input 1 or 2 is inactive
		Off	Power input 1 and 2 are both functional, or no power inputs
1 ~ 8 (Upper LED)	Green	On	Connected to network
		Flashing	Networking is active
		Off	Not connected to network
1 ~ 8 (Lower LED)	Yellow	On	Connected to network at speed of 1000Mbps
		Off	Not connected to network or not working at speed of 1000Mbps

## RJ-45 Pin Assignments

The UTP/STP ports will automatically sense for Fast Ethernet (10Base-T/100Base-TX) or Gigabit Ethernet (10Base-T/100Base-TX/1000Base-T) connection. Auto MDI/MDIX means that the switch can connect to another switch or workstation without changing straight through or crossover cabling. See the figures below for straight through and crossover cable schema.

### ■ 10/100Base-TX Pinouts

Pin Number	Assignment
1	Tx+
2	Tx-
3	Rx+
6	Rx-

*Note* “+” and “-” signs represent the polarity of the wires that make up each wire pair.

The table below shows the 10Base-T/100Base-TX MDI and MDI-X port pinouts.

Pin Number	MDI-X Signal Name	MDI Signal Name
1	Receive Data plus (RD+)	Transmit Data plus (TD+)
2	Receive Data minus (RD-)	Transmit Data minus (TD-)
3	Transmit Data plus (TD+)	Receive Data plus (RD+)
6	Transmit Data minus (TD-)	Receive Data minus (RD-)

■ **10/100Base-TX Cable Schema**

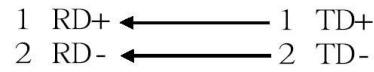
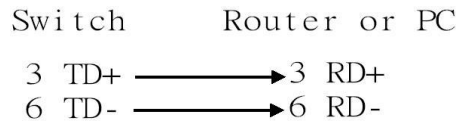

**Straight Through Cable Schema**

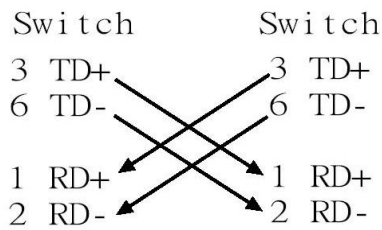

**Crossover Cable Schema**

■ **10/100/1000Base-T Pinouts**

The table below describes the gigabit Ethernet RJ-45 pinouts.

Pin	Signal name	Description
1	BI_DA+	Bi-directional pair A+
2	BI_DA-	Bi-directional pair A-
3	BI_DB+	Bi-directional pair B+
4	BI_DC+	Bi-directional pair C+
5	BI_DC-	Bi-directional pair C-
6	BI_DB-	Bi-directional pair B-
7	BI_DD+	Bi-directional pair D+
8	BI_DD-	Bi-directional pair D-

■ **10/100/1000Base-T Cable Schema**

The following two figures illustrate the 10/100/1000Base-T cable schema.

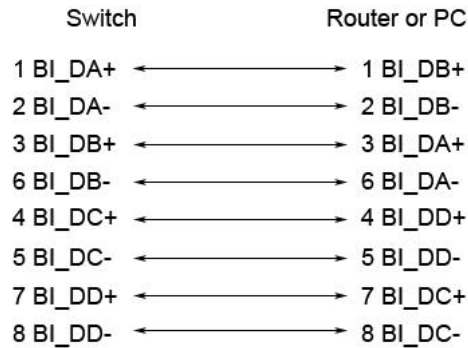

Straight Through Cable Schema

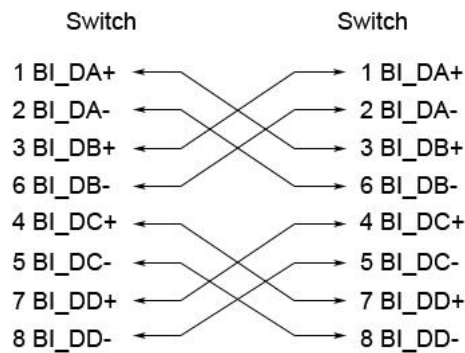

Crossover Cable Schema

## Cabling

Use unshielded twisted-pair (UTP) or shielded twisted-pair (STP) cable for RJ-45 connections: 100Ω Category 3, 4 or 5 cable for 10Mbps connections, 100Ω Category 5 cable for 100Mbps, or 100Ω Category 5e/above cable for 1000Mbps connections.

The cable between the switch and the link partner (switch, hub, workstation, etc.) must be less than 100 meters (328 ft.) long.

# Mounting Installation

---

## DIN-Rail Mounting

### Assembling the DIN-Rail Clip

The DIN-rail clip is screwed on the industrial switch when out of factory. If not, please refer to the following steps and figure to secure the DIN-rail clip on the switch.

- 1, Use the screws to screw on the DIN-rail clip on the industrial switch.
- 2, To remove the DIN-rail clip, reverse step 1.

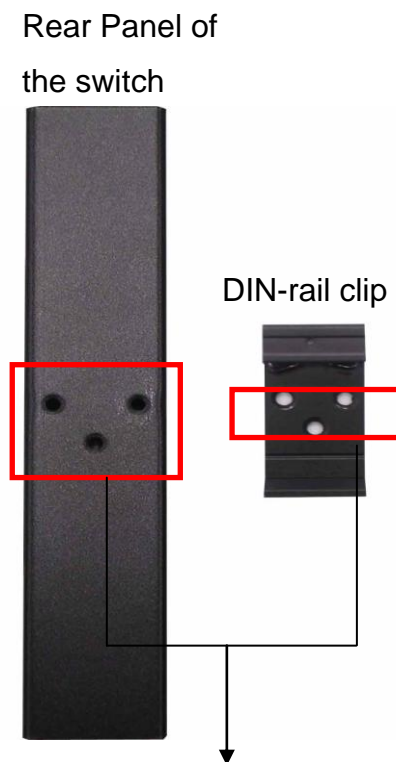



## Hanging the Industrial Switch

Follow the steps below to hang the industrial switch on the DIN rail.

- 1, First, position the rear side of the switch directly in front of the DIN rail. Make sure the top of the clip hooks over the top of the DIN rail.



- 2, Push the unit downward.

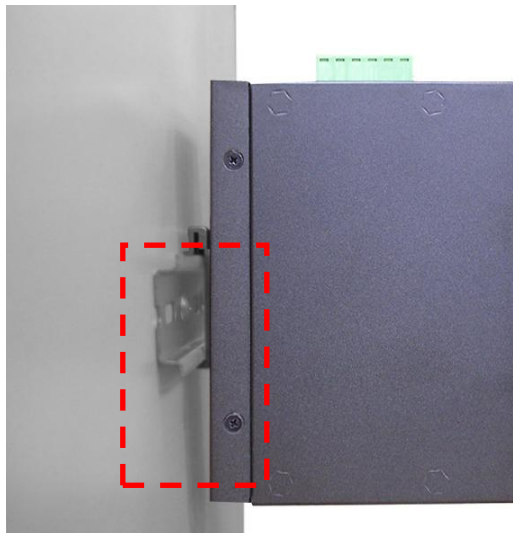

- 3, Check the DIN-Rail clip is tightly fixed on the DIN rail.
- 4, To remove the industrial switch from the track, reverse the steps above.

## Wall-Mount Plate Mounting

**\*Optional Wall Mount Kit required**

Follow the steps below to mount the industrial switch with the wall mount plates included.

1. To remove the DIN-Rail clip from the industrial switch, unscrew the screws to remove the DIN-Rail clip.
2. Place the wall-mount plates on the rear panel of the industrial switch.
3. Use the screws to secure the wall-mount plates on the industrial switch.
4. Use the hook holes at the corners of the wall-mount plates to hang the industrial switch on the wall.
5. To remove the wall-mount plates, reverse the steps above.

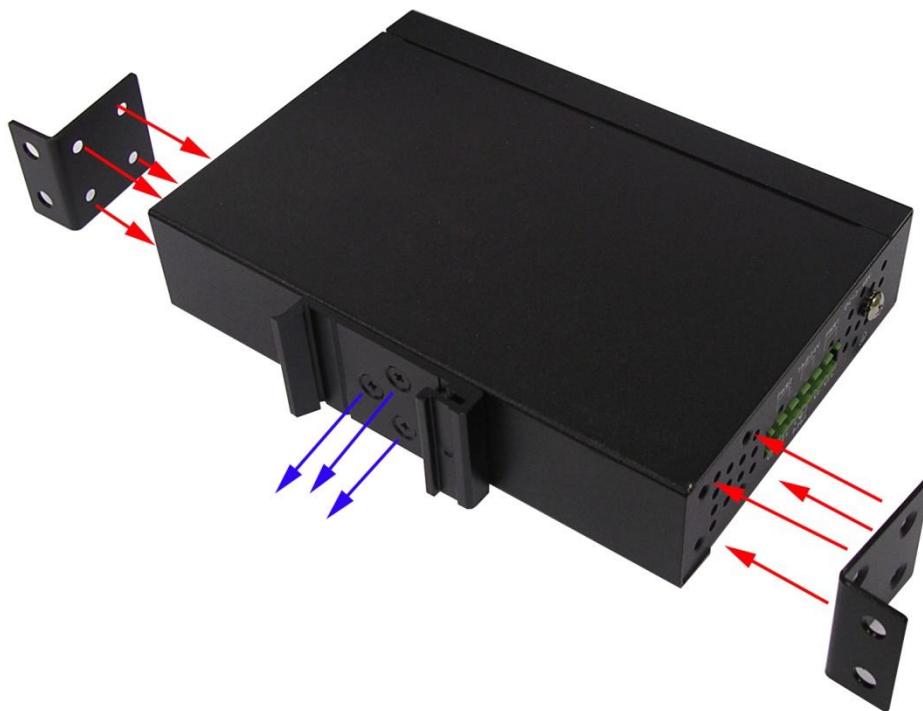

# Hardware Installation

---

In this paragraph, we will describe how to install the 8-port 10/100/1000Base-TX Industrial Switch and the installation points for the attention.

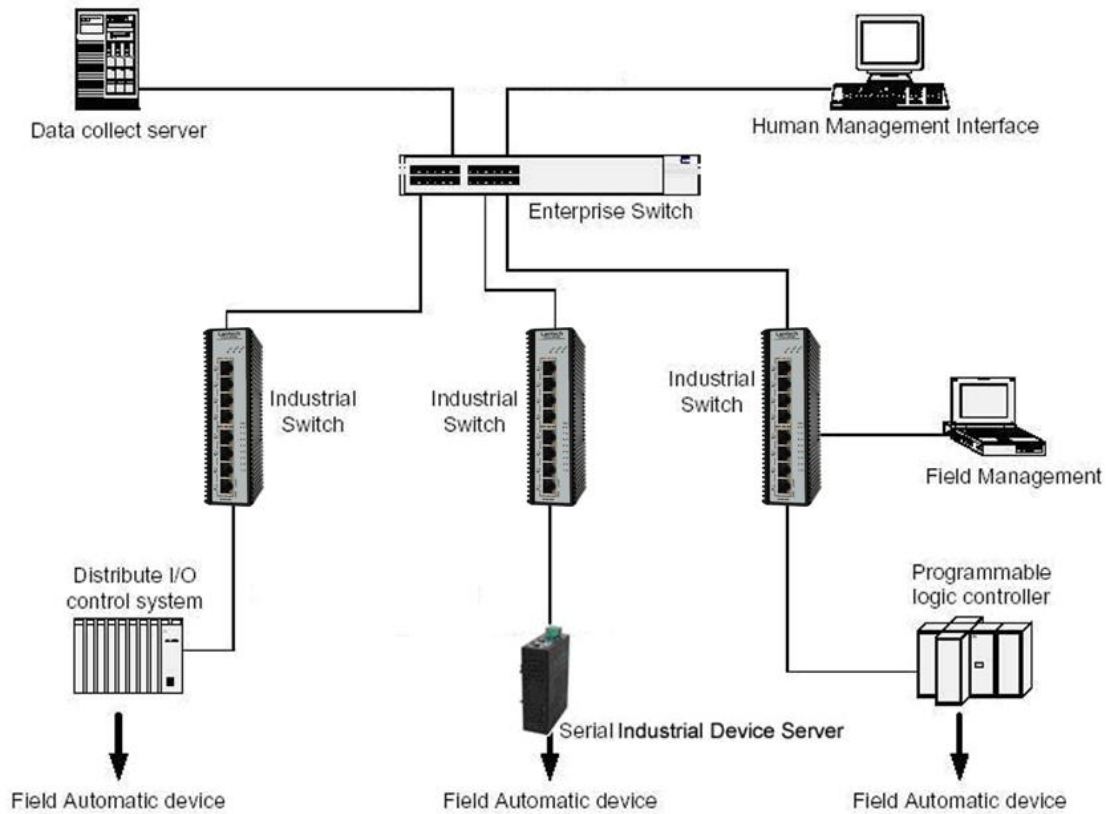

## Installation Steps

1. Unpacked the Industrial switch.
2. Check the DIN-Rail is screwed on the Industrial switch. If the DIN-Rail is not screwed on the Industrial switch. Please refer to **DIN-Rail Mounting** section for DIN-Rail installation. If you want to wall mount the Industrial switch, then please refer to **Wall-Mount Plate Mounting** section for wall mount plate installation.
3. To hang the Industrial switch on the DIN-Rail track or wall, please refer to the **Mounting Installation** section.
4. Power on the Industrial switch. How to wire the power; please refer to the **Wiring the Power Inputs** section. The power LED on the Industrial switch will light up. Please refer to the **LED Indicators** section for meaning of LED lights.
5. Prepare the twisted-pair, straight through Category 5e cable for Ethernet connection.
6. Insert one side of Category 5e or above cable into the Industrial switch RJ-45 port and another side of category 5e or above cable to the network devices' RJ-45 port, ex: switch, PC or Server. The RJ-45 LED indicator on the Industrial switch will light up when the cable is connected with the network device. Please refer to the **LED Indicators** section for LED light meaning.
7. When all connections are all set and LED lights all show in normal, the installation is complete.

# Troubleshooting

---

- Verify that you are using the included or appropriate power cord/adapter. Don't use the power adapter with DC output higher than the power rating of the device. Otherwise, the device will burn down.
- Select the proper UTP/STP cable to construct your network. Please check that you are using the right cable. Use unshielded twisted-pair (UTP) or shielded twisted-pair (STP) cable for RJ-45 connections: 100Ω Category 3, 4 or 5 cable for 10Mbps connections, 100Ω Category 5 cable for 100Mbps, or 100Ω Category 5e/above cable for 1000Mbps connections. Also be sure that the length of any twisted-pair connection does not exceed 100 meters (328 feet).
- **Diagnosing LED Indicators:** The Switch can be easily monitored through panel indicators, which describes common problems you may encounter and where you can find possible solutions, to assist in identifying problems.
- IF the power indicator does not light on when the power cord is plugged in, you may have a problem with power cord. Then check for loose power connections, power losses or surges at power outlet. If you still cannot resolve the problem, contact your local dealer for assistance.
- If the Industrial switch LED indicators function normal and the connected cables are correct but the packets still cannot transmit, please check your system's Ethernet devices' configuration or status.